



# OWNERS MANUAL





# TABLE OF CONTENTS

7 ..... **1**    **INTRO**

7 ..... **2**    **OVERVIEW**

7 ..... **2.1.** **Front**

8 ..... **2.2.** **Back**

8 ..... **2.3.** **Menu Navigation**

9 ..... **3**    **QUICK START**

9 ..... **4**    **MEMORY MANAGEMENT**

10 ..... **4.1.** **SD Card**

10 ..... **4.2.** **Projects**

10 ..... **4.3.** **Kits**

10 ..... **4.4.** **Patterns**

10 ..... **4.5.** **Songs**

10 ..... **5**    **VOICES**

10 ..... **5.1.** **Drum voices (voice 1-3)**

11 ..... **5.2.** **Snare voice (voice 4)**

11 ..... **5.3.** **Cymbal/Clap (voice 5)**

11 ..... **5.4.** **Hi-hat voice (6)**

11 ..... **5.5.** **Voice parameter menu sections**

11 ..... Oscillator Page (OSC)

12 ..... Amplitude Envelope Page (AEG)

13 ..... Modulation Page (MOD)

13 ..... Frequency Modulation Page (FM)

14 ..... Transient Generator Page (Click)

14 ..... Filter Page (FIL)

14 ..... LFO Page (LFO)

15 ..... Mixer Page (Mix)

15 ..... **6**    **SEQUENCER**

15 ..... **6.1.** **Tracks**

15 ..... Select tracks

15 ..... Mute tracks

16 ..... Unmute all tracks

16 ..... Track length

16 ..... **6.2.** **Bars**

16 ..... **6.3.** **Steps**

16 ..... **6.4.** **Step parameters**

16 ..... Available Step Parameters

17 ..... **6.5.** **Automation**

17 ..... Choosing the active automation track

17 ..... How to assign parameter automation

17 ..... Clear automation data

17 ..... **6.6.** **Pattern**

18 ..... Basic pattern editing

18 ..... **6.7.** **Copy sequencer data**

18 ..... **6.8.** **Clear sequencer data**

18 ..... Clear Pattern

18 ..... Clear Track

18 ..... **7**    **OPERATION MODES**

18 ..... **7.1.** **Voice edit mode**

19 ..... Pattern editing

19 ..... Sound editing

19 ..... Clear kit / Init sound

19 ..... **7.2.** **Step (Edit) mode**

20 ..... Step Parameter editing

20	.....	<b>7.3. Performance Mode</b>
20	.....	Basic performance menu
20	.....	Manual Roll
20	.....	Morph
20	.....	Shuffle
20	.....	<b>7.4. Loading and saving</b>
21	.....	Display description
21	.....	Menu navigation
21	.....	Kits
22	.....	Morph Kits
22	.....	Songs
22	.....	Patterns
22	.....	Project
22	.....	<b>7.5. Pattern Generator Mode</b>
23	.....	Menu location
23	.....	Pattern generator menu
23	.....	Generating patterns
23	.....	<b>7.6. Global settings menu</b>
23	.....	Menu location
23	.....	Menu options
24	.....	Screensaver
24	.....	Loading and saving of global settings
24	.....	<b>7.7. Pattern Menu</b>
24	.....	Changing the pattern
25	.....	<b>7.8. Song Mode</b>
25	.....	Editing songs
25	.....	Using the sequencer buttons to add patterns
25	.....	Inserting an removing lines
25	.....	Special Patterns
25	.....	Playing a song
26	.....	<b>7.9. FX Mode</b>

26	.....	Menu location
26	.....	Drive
26	.....	Ringmodulator
27	.....	Compressor
27	.....	Delay
27	.....	<b>7.10. Reload Button</b>
28	.....	<b>8 SYNTH MODULES</b>
28	.....	<b>8.1. Oscillator</b>
28	.....	<b>8.2. Filter</b>
28	.....	Frequency
28	.....	Resonance
28	.....	Drive
28	.....	Filter types
30	.....	<b>8.3. Envelopes</b>
30	.....	Attack/Decay times
31	.....	Slope
31	.....	Repeat
31	.....	<b>8.4. Transient generator</b>
32	.....	Snappy mode
32	.....	Offset mode
32	.....	Sample mode
32	.....	Parameters
33	.....	<b>8.5. Sample Rate Reduction</b>
33	.....	<b>8.6. Distortion</b>
33	.....	<b>8.7. LFO</b>
33	.....	Setting up modulations
34	.....	<b>8.8. Velocity modulation</b>
34	.....	<b>8.9. Output Routing</b>
34	.....	<b>9 MIDI</b>

34	.....	<b>9.1. MIDI channel</b>
34	.....	Global MIDI channels
34	.....	Voice MIDI channel
34	.....	<b>9.2. Midi routing (midi soft thru)</b>
34	.....	<b>9.3. MIDI filtering</b>
35	.....	<b>9.4. MIDI Sync</b>
35	.....	<b>9.5. Record incoming MIDI</b>
35	.....	Recording melodies
35	.....	<b>9.6. Transmitting sequencer data to the MIDI out</b>
35	.....	<b>9.7. MIDI CC list</b>
37	.....	<b>9.8. MIDI NRPN list</b>
39	.....	<b>10 FIRMWARE UPDATE</b>
39	.....	<b>10.1. Update procedure</b>
39	.....	<b>10.2. Bootloader error messages</b>
39	.....	<b>11 INTRODUCTION TO DRUM SYNTHESIS</b>
39	.....	<b>11.1. Kicks</b>
40	.....	<b>11.2. Snare</b>
40	.....	<b>11.3. Clap</b>
41	.....	<b>11.4. Hi-hat</b>
41	.....	<b>11.5. Cymbal ride</b>
41	.....	<b>11.6. Bells</b>
41	.....	Realistic bells
41	.....	808 style cowbell
42	.....	<b>11.7. More info about drum sound design</b>
42	.....	<b>12 TECHNICAL INFORMATION</b>
42	.....	<b>12.1. Electrical Specification</b>
42	.....	<b>12.2. Hardware</b>
42	.....	<b>12.3. Physical Specification</b>

12V DC

OFF / ON

CLK IN

CLK OUT

RST IN

SD CARD

USB

MIDI IN

MIDI OUT

L

OUT 2

R

L

MAIN OUT

R

PHONES

1

**LXR** 

DIGITAL DRUM SYNTH

HELLO HUMAN

7



DATA

8

DRUM1 DRUM2 DRUM3 SNARE CLP/CYM HIHATS VOLUME

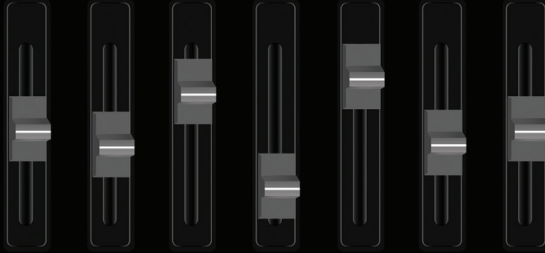

2



9

BAR



10

DRUM1 DRUM2 DRUM3 SNARE CLP/CYM CL HH OP HH



4

SHIFT



3

PLAY REC



5

COPY CLR



11

VOICE PERF LOAD SAVE



12

OSC AEG MOD FM CLICK FILTER LFO MIX



DRUM1 DRUM2 DRUM3 SNARE CLP/CYM CL HH OP HH KIT MORPH SONG PROJECT CONFIG RELOAD LAST STEP FX PATTERN



6

LXR-02

SONIC POTIONS X ERICA SYNTHS

# 1 > INTRO

## THANK YOU FOR PURCHASING THE ERICA SYNTHS X SONIC POTIONS LXR-02 SYNTHESIZER!

The LXR is a fully-fledged digital drum machine with an integrated sequencer. Its sound engine provides 6 different instruments, each with over 30 parameters to tweak. It can produce a wide variety of sounds, ranging from classic analogue emulations to crunchy digital mayhem.

# 2 > OVERVIEW

In this first chapter we will focus on the physical appearance of the LXR, describing the front panel controls as well as the connection jacks on the back. Further, the basic menu navigation is explained.

## 2.1. FRONT

### 1 DISPLAY

The display is used to show parameter values from the selected menu page.

### 2 KNOBS

The 4 encoders are used to edit the values shown in the display above.

### 3 RECORD/PLAY BUTTONS

The PLAY button starts and stops the playback. The current pattern is reset to the first step when the sequencer is re-started.

The RECORD button activates the recording function. If the LED is lit, all incoming MIDI notes will be recorded to the active pattern. Knob movements will also be recorded to the selected automation track.

### 4 SHIFT BUTTON

Activates an alternate function set for some buttons, indicated by the white background labels.

### 5 COPY/CLEAR BUTTON

Copy and clear sequencer and kit data.

### 6 16 SEQUENCER BUTTONS

Function depending on active mode  
> Voice mode: set and clear active steps in the sequencer.  
> Performance Mode: Buttons 1 to 7 are used to trigger manual rolls. Buttons 8-16 are unused at the moment.  
> Step Edit Mode: select a step to edit the step parameters.  
> Used together with the shift button, to access special menus.

### 7 ENCODER

Navigate through the menu.

### 8 VOLUME FADERS

There are 6 faders that control the volume of the individual voices as well as a main volume fader.

### 9 BAR BUTTONS

To edit a 64 step Pattern with only 16 sequencer buttons, the pattern is split into 4 bars with 16 steps each. The bar buttons are used to select which of the 4 bars to show on the buttons.



### 10 7 VOICE BUTTONS

The voice buttons select the active track to edit. Together with the shift key they will mute/unmute the voices.

### 11 4 MODE BUTTONS

Switch between the 4 main operating modes.  
VOICE - Voice edit mode [a second push toggles step edit mode]  
PERF - Performance mode [Pattern generator mode]  
LOAD - Load data  
SAVE - Save data

### 12 8 SELECT BUTTONS

Select the synthesis section to edit [Oscillators, Mixer, Envelopes etc.]



## 2.2. BACK

### 1 PHONES CONNECTOR

3.5 mm audio output for stereo headphones.

### 2 AUDIO OUTS

4 x 1/4" mono audio, line-level (+4dBu) outputs. Can be used as stereo output pairs as well.

### 3 MIDI OUT

MIDI output

### 4 MIDI IN

MIDI input with soft thru option.

### 5 USB

Electrically isolated hi-speed USB 2.0 port. Class compliant USB MIDI interface to connect the LXR to a computer.

### 6 SD CARD

Memory card slot to save project data.

### 7 ANALOGUE CLOCK IO

Clock IO for synchronization with analogue gear using 5V signal levels.

### 8 POWER

Switch for turning the unit on and off.

### 9 DC IN

Center positive 5.5 x 2.5 mm barrel jack, 12 V DC, 1 A.

## 2.3. MENU NAVIGATION

The upper row of the display will show the short name of the parameter. The bottom row shows the value of the parameter. You can change the value using one of the 4 knobs below the display.

frq	RES	typ	drv >
32	120	LP	0

> The encoder selects a menu parameter. Capital letters highlight the selected parameter. In our example picture above, the 'RES' parameter is selected.

> If there are more than 4 entries in the current menu, the next page will be shown if you scroll over the screen boundary. A '>' or '<' sign in the right upper corner indicates if there is a 2nd page available and which page is active. The 2 pages of a menu can be toggled by pressing the menu button again.

If you push the encoder the detail page is shown

Filter	
Resonance	120

On the detail page you can see the full name of the parameter and change its value using the encoder. This is good for fine adjustments, where the knob control is too coarse. By pushing the encoder again, you return to the normal menu mode.



## 3 > QUICK START

The LXR-02 comes with a universal wall wart PSU for worldwide use. Install the appropriate adapter on the PSU and connect the LXR to a power outlet. Use cables with 6.3mm jacks to connect the main output to the mixer and start making beats!

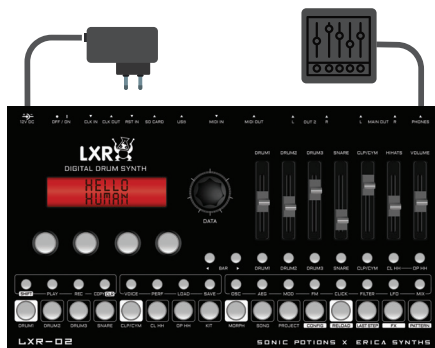

The fastest way to get some beats out of your new box!

- > Make sure the SD card is inserted in the LXR
- > Power up the synth.
- > Press the PLAY button. The chaselight starts running.
- > Adjust the volume faders so they are not at zero volume.
- > Use the 16 SEQUENCER buttons to activate some steps. Now you should hear the first voice playing.
- > Use the 7 VOICE buttons to change the active track/voice
- > Again, use the 16 SEQUENCER buttons to activate some steps. The next voice should now play as well.
- > Press the LOAD + KIT (Step 8) buttons together. You are now in the kit load mode.
- > Use the encoder to select another preset. Confirm the selection by pushing the encoder. This will load a new kit and the sound will change accordingly.

## 4 > MEMORY MANAGEMENT



The LXR operates with all data (Kits, Patterns, Songs etc) loaded into the internal RAM. The data is loaded from the SD card during power up. All edits are made to the volatile copy of the files in RAM. **If you power down the LXR without manually saving the project, all changes will be lost! Data will only be written back to the SD card for permanent storage once a PROJECT is saved!**

The following image outlines the LXR's data structure.

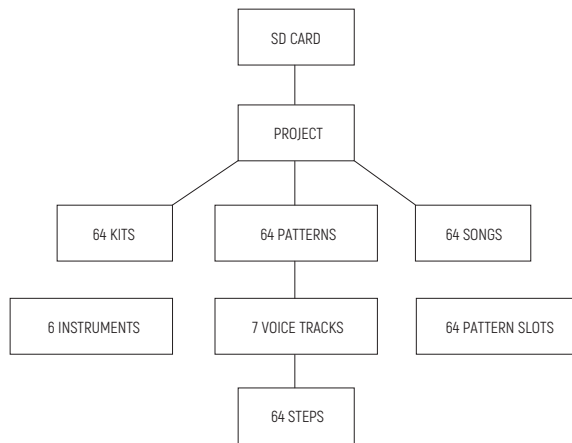

## 4.1. SD CARD

The memory card is used as non volatile storage. Without a memory card you are not able to save your work!

## 4.2. PROJECTS

The LXR can handle 64 projects stored on the SD card. A project consists of 64 Kits, Patterns and Songs as well as the project setting files. Projects are created as folders on the memory card.

## 4.3. KITS

A kit contains the instrument data for the 6 Voices. All synthesis parameters are stored here. Kits are stored as .SND binary files inside the Project folder. The factory preset kits are developed by Leoš Hort aka hrtl.

## 4.4. PATTERNS

A Project contains 64 Patterns, each with 7 Tracks containing 64 Steps in 4 Bars. Patterns contain the note and automation data for each instrument. They are saved as .PAT files inside the project folder.

## 4.5. SONGS

A Project contains 64 Songs. Each song is a list with up to 64 Patterns that will be played one after another.

# 5 > VOICES

The LXR offers 6 voices. They are optimized for different kinds of drum sounds. The type of a voice can not be changed. There are 3 drum voices, a subtractive clap/snare voice, an FM percussion voice and a hi-hat voice. In this chapter a diagram of the synthesis structure is shown for each voice type, then the parameters are explained. Let's take a closer look at the voice types.

## 5.1. DRUM VOICES (VOICE 1-3)

The drum voices are useful but not limited to kick drums, toms, cowbells and other drum sounds.

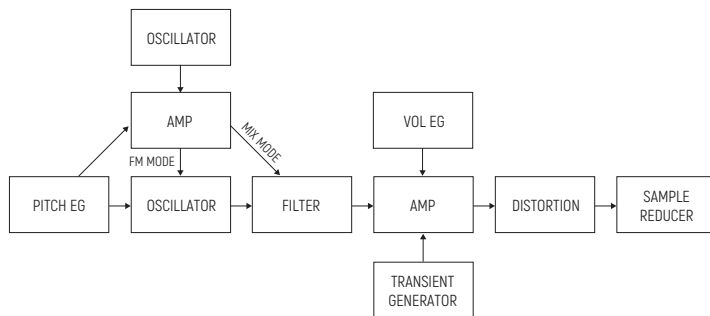

## 5.2. SNARE VOICE (VOICE 4)

This voice is good for snare-drum and clap sounds. A noise source and a pitched oscillator can be mixed. Only the noise source is routed through the filter. There is no FM capability on this voice.

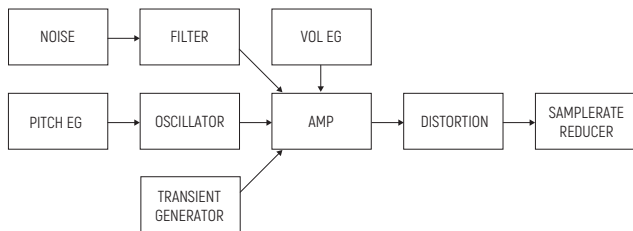

## 5.3. CYMBAL/CLAP (VOICE 5)

This voice uses a 3 operator FM to generate the sound. The main oscillator is modulated by 2 modulation oscillators. It's great for metallic and noisy sounds!

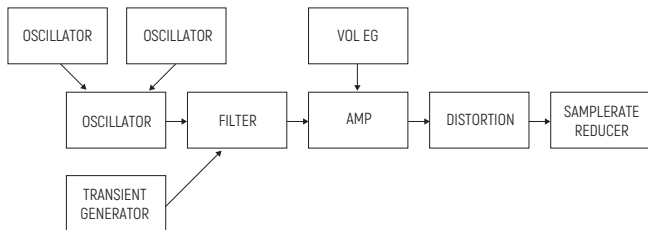

## 5.4. HI-HAT VOICE (6)

The hi-hat voice is nearly identical to the Cymbal voice, but it offers 2 different decay times for the amplitude envelope. The voice is shared between sequencer tracks 6 and 7, each using one of the 2 available decay times. This allows for playing open and closed hi-hats. The closed hat (track 6) will choke the open hat (track 7).

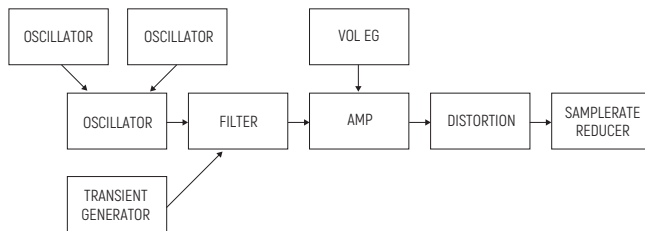

## 5.5. VOICE PARAMETER MENU SECTIONS

The synthesis parameters of each voice can be altered in voice edit mode. The synthesis engine is grouped into 8 different sections that can be selected with the select buttons. In this section each of those 8 menu pages and their parameters are described.

### OSCILLATOR PAGE (OSC)

Provides access to the main oscillator parameters. Frequency and waveform of the main oscillator can be set here.

### Drum 1-3, Clap, Hi-Hat

Displayed name	Name	Description
coa	Coarse tune	Coarse tuning of the main oscillator in semitones.
fin	Fine tune	Fine tuning of the main oscillator +/- 50 cent.
wav	Waveform	The waveform of the main oscillator.
pwm	Pulsewidth	If the PWM waveform is selected, its duty cycle can be adjusted here.

### Snare

Displayed name	Name	Description
coa	Coarse tune	Coarse tuning of the main oscillator in semitones.
fin	Fine tune	Fine tuning of the main oscillator +/- 50 cent.
noi	Noise frequency	Coarse tuning of the noise oscillator.
mix	Oscillator mix	Mix ratio between oscillator and noise source.
wav	Waveform	The waveform of the main oscillator.
pwm	Pulsewidth	If the PWM waveform is selected, its duty cycle can be adjusted here.

### AMPLITUDE ENVELOPE PAGE (AEG)

Each voice has an amplitude envelope. The common parameters are attack and decay time as well as the slope of the curve.

#### Drum 1-3

Displayed name	Name	Description
att	Amplitude envelope attack	Rise time of the envelope.
dec	Amplitude envelope decay	Fall time of the envelope.
slp	Amplitude envelope slope	Variable slope from exp to linear to logarithmic.

#### Snare/Cymbal

Displayed name	Name	Description
att	Amplitude envelope attack	Rise time of the envelope.
dec	Amplitude envelope decay	Fall time of the envelope.
rpt	Repeat count	Number of retriggers.
slp	Amplitude envelope slope	Variable slope from exp to linear to logarithmic.

#### Hi-Hat

Displayed name	Name	Description
att	Amplitude envelope attack	Rise time of the envelope.
D1 / D2	Closed / Open hi-hat decay time	Envelope fall time for the hi-hats.
slp	Amplitude envelope slope	Variable slope from exp to lin to log.

## MODULATION PAGE (MOD)

The modulation page contains the velocity modulation parameters. Here you can turn the velocity volume modulation on and off and route the note velocity to any synthesis parameter you like. If the selected voice offers a second envelope, its parameters can be found on the modulation page as well.

### Drum 1-3, Snare

Displayed name	Name	Description
dec	Modulation envelope decay	Fall time of the envelope.
slp	Modulation envelope slope	Variable slope from exp to linear to logarithmic.
mod	Modulation envelope amount	> Controls how strongly the envelope modulates its target. > The envelope is hardwired to the pitch. This parameter controls the pitch modulation intensity. > In FM mode the EG is additionally hardwired to the FM amount.
dstr	Velocity mod. destination	The note velocity can be routed to any voice parameter. Here you can select the target from a list.
amt	Velocity mod. amount	Amount of the velocity modulation.
vol	Velocity to volume modulation	Can be either On or Off. If activated the note velocity controls the voice volume.

### Clap, Hi-Hat

Displayed name	Name	Description
dst	Velocity mod. destination	The note velocity can be routed to any voice parameter. Here you can select the target from a list.
amt	Velocity mod. amount	Amount of the velocity modulation.
vol	Velocity to volume modulation	Can be either On or Off. If activated the note velocity controls the voice volume.

## FREQUENCY MODULATION PAGE (FM)

The FM page hosts the frequency, waveform and modulation amount settings for the FM oscillators.

Displayed name	Name	Description
amt	Modulation amount [mix ratio]	FM mode: modulation amount Mix mode: Mix ratio of the 2 OSCs.
frq	Frequency of the FM OSC	Coarse tuning of the FM oscillator in semitones.
wav	Waveform of the FM OSC	The waveform of the FM oscillator.
mod	Oscillator mode	FM mode: the main OSC is modulated by the FM OSC Mix mode: The main OSC and FM OSC are mixed.

## SNARE

Voice 4 offers no FM capabilities at the moment, so the Page is empty.

### Clap, Hi-Hat

Displayed name	Name	Description
f1	Frequency 1	Frequency of the first modulation oscillator.
f2	Frequency 2	Frequency of the second modulation oscillator.
g1	Gain 1	Gain of the first modulation oscillator.
g2	Gain 2	Gain of the second modulation oscillator.
wav	Waveform 1	Waveform of the first modulation oscillator.
wav	Waveform 2	Waveform of the second modulation oscillator.

### TRANSIENT GENERATOR PAGE (CLICK)

The transient generator parameters are the waveform, volume and frequency of an additional short attack transient that can be mixed to the voice output.

Displayed name	Name	Description
wav	Transient wave shape	Selects the transient sample to play.
vol	Transient volume	Volume of the transient sample.
frq	Transient frequency	Frequency of the transient sample.

## FILTER PAGE (FIL)

All parameters of the filter are on this page. The available parameters are frequency, resonance, type and drive.

Displayed name	Name	Description
frq	Filter frequency	Changes the cutoff frequency of the filter.
res	Filter resonance	Adjusts the filter resonance.
typ	Filter type	Selects the filter characteristic.
drv	Filter drive	Increases the input gain of the filter.

## LFO PAGE (LFO)

Each voice has an LFO that can be edited on this page.

Displayed name	Name	Description
frq	LFO frequency	Manual LFO rate control. Only available when sync is turned off!
sync	LFO sync	Activates the LFO clock sync. Different sync rates can be selected ( $\frac{1}{2}$ , $\frac{1}{4}$ etc.).
mod	Modulation amount	Controls how strongly the LFO signal affects the target.
wav	LFO waveform	Select the LFO waveform. > Sine [sin] > Triangle [tri] > Saw up [sup] > Saw down [sdn] > Square [sqr] > Random [rnd] > Exponential saw up [xup] > Exponential saw down [xdn]

rtg	LFO retrigger	Allows the LFO to be retriggered from different sequencer tracks. Select the voice that should retrigger the LFO (v1-v6) and it will reset its phase whenever a note is played on the selected track.
off	Phase offset	When the LFO is retriggered, it is reset to the selected phase offset.
voi	Destination voice	Select the target voice. This parameter will change the displayed target list of the destination select parameter.
dst	Destination select parameter	Select the parameter to modulate. It shows a list with the short names from all the parameters of the selected target voice.

### MIXER PAGE (MIX)

The mixer page provides access to volume, panning, routing, voice FX and sequencer track length.

Displayed name	Name	Description
vol	Voice volume	Adjusts the volume of the voice.
pan	Voice panning	Voice panning. Only active if output is set to a stereo channel.
sr	Sample rate	Sample rate decimation.
drv	Drive	Soft clipping amount.
out	Output	Selects the hardware audio out for this voice. The voice can either be routed to one of the 2 stereo channels or use the 4 outputs as individual mono channels or the FX bus.

len	Track length	The length of the sequencer track in 16th steps.
ch	MIDI channel	MIDI channel the voice responds to.
nte	Note	MIDI note the instrument responds to. If set to "any", the voice can be played tonally with all notes on the channel.

## 6 > SEQUENCER

The synth has a sequencer to play and program different drum patterns. The basic functionality is quite similar to the well known TR-x0x machines, but there is more to it.

### 6.1. TRACKS

The drum voices are useful but not limited to kick drums, toms, cowbells and other drum sounds.

#### SELECT TRACKS

The active track can be changed with the 7 VOICE buttons below the volume faders. A lit LED on the button shows the selected track.

#### MUTE TRACKS

If the SHIFT button is held, the sequencer tracks can be muted with the VOICE buttons. The LEDs of the unmuted voices will light up.



While in performance mode, the function of the VOICE buttons is inverted. They mute/unmute the tracks without holding SHIFT. This allows for single-handed operation.

## UNMUTE ALL TRACKS

To unmute all muted tracks simultaneously, go to performance mode and hold down the SHIFT button. Now the VOICE buttons will unmute all tracks up to the selected track.

An example:

SHIFT + VOICE Button 4 = track 1, 2, 3 and 4 will be unmuted.

SHIFT + VOICE Button 7 = all tracks are unmuted.

## TRACK LENGTH

There are multiple ways to set the track length

### Mixer Page length parameter

The length of a track can be set on the mixer page of the corresponding voice with the "len" parameter. Tracks can be anywhere from 1 to 64 steps.

### Last Step Button

Another way to set the track length is to use the Last Step button.

> Press SHIFT + LAST STEP (seq 14).

> Use the SEQUENCER buttons to select the new last step.

> Use the BAR buttons to select steps above step 16.

> You can also set last step with the encoder.

> You can choose the track for which to edit the last step with the voice buttons.

> SHIFT + double LAST STEP key press enters the page where you can set last step for all tracks at the same time.

> To exit the LAST STEP page press the VOICE button!

### Bar Buttons

You can also use the BAR buttons to change the track length.

SHIFT + BAR UP extends the track length by 16 steps.

SHIFT + BAR DOWN shrinks the track length by 16 steps.

If you want, you can extend the track and copy the step data from steps 1-16 to the steps 17-32, use COPY + BAR to fill the next bar with the current bar data.

## 6.2. BARS

A pattern contains up to 4 bars, each with 16 steps. The SEQUENCER buttons only show 16 steps at a time. To view the next or previous bar, the BAR UP and BAR DOWN buttons are used. You can also enable bar following in the configure menu with FLW setting!

## 6.3. STEPS

There are up to 64 steps per track. Steps can be set/removed using the 16 sequencer buttons.

## 6.4. STEP PARAMETERS

Each step has a set of parameters. To edit the step parameters in voice edit mode, hold down the shift button. The display will now show the step parameter page and the LED of the selected step will start flashing.

### AVAILABLE STEP PARAMETERS

The display shows the following parameters:

Displayed name	Name	Description
vel	Step Velocity	Note on velocity of the step (0-127). Can be used as a mod source on the voice modulation page.
nnt	Step Note	MIDI Note number to play [C0:G10]. The note value also depends on the set tuning of the OSC.
prb	Step Probability	The chance of the step being played as percent value. If set to '0%' the step will never be played, set to '50' and there is a 50% chance it will be played, '100%' always plays the step.



## 6.5. AUTOMATION

Parameter values can be recorded to the sequencer steps. Each step can store 2 parameter changes. They affect only a single step and are not processed if the step is inactive. The modulation targets can be different on every step.

### CHOOSING THE ACTIVE AUTOMATION TRACK

Before you start recording parameter changes select the active automation track. There are 2 automation tracks per voice. You have to select the active track before you record new data. If data is already present on the active track, it will be overwritten!

- > Hold SHIFT and press the REC button. The record options are shown in the menu.
- > The parameter ["trk"] selects the active automation track to which the data will be recorded.

### HOW TO ASSIGN PARAMETER AUTOMATION

There are several ways to assign automation parameters to a step:

#### Realtime recording

- > Activate the recording mode by pressing the REC button. The record LED will light up.
- > While the pattern is playing, tweak some sound parameters using the knobs. The parameter changes will be recorded to the played steps.

#### Lock parameter values to a single step using the 4 knobs

You can also assign a parameter change directly to a single step.

- > In voice edit mode, hold down the SEQUENCER button.
- > The LED of the step starts blinking.
- > Use one of the 4 knobs to assign a parameter value to the step.
- > Release the SEQUENCER button.
- > The changed parameter is now locked to this step.

### Edit automation using the step edit menu

The automation data can also be edited manually.

- > Go to the step parameter menu. (step edit mode, blinking voice mode LED).
- > Use the encoder to scroll to page 2.
- > There you will see:

Displayed name	Name	Description
p1d	Parameter 1 Destination	Select the target voice parameter from a list.
p1v	Parameter 1 Value	Set the parameter to this value on this step.
p2d	Parameter 2 Destination	Select the target voice parameter from a list.
p2v	Parameter 2 Value	Set the parameter to this value on this step.

The manual edit is the only way to assign parameter automations from one track to another. It is advised to edit the target parameter in edit mode (push encoder), since only then the full names as well as the destination voice is shown.

### CLEAR AUTOMATION DATA

A whole automation track can be cleared.

- > Hold down SHIFT and press the COPY/CLEAR button.
- > While still holding the SHIFT button, use the encoder to select 'Clear [autom.1/2]?' on the display.
- > Press COPY/CLEAR again to confirm, release the SHIFT button to abort the action.

## 6.6. PATTERN

A set of all 7 tracks is called a pattern. You can chain different patterns to be played after one another. See the song mode section for more information.

## BASIC PATTERN EDITING

Basic pattern editing is done in VOICE edit mode. Select the track you want to edit with the VOICE buttons. The step data will be displayed on the 16 sequencer button LEDs. You can then use the SEQUENCER buttons to set and remove steps.

### 6.7. COPY SEQUENCER DATA

You can copy the content of one track to another:

- > Push and hold the COPY button.
- > It's LED will start flashing.
- > Now, while still holding the COPY button, press the VOICE button of the track you want to copy.
- > The voice button will flash, too.
- > Now push the target VOICE button of the track you want to copy to.
- > All buttons stop flashing and the track is copied to the destination.
- > To abort the process, just release the copy button.

### 6.8. CLEAR SEQUENCER DATA

The sequencer data can be cleared to start over from an empty track or pattern.

#### CLEAR PATTERN

The whole pattern with all tracks will be cleared.

- > Press SHIFT + CLEAR
- > Use the encoder to select "clear [pattern]?" on the display.
- > Push CLEAR again to confirm or release the SHIFT button to abort.

#### CLEAR TRACK

To clear a single track in the pattern:

- > Use the VOICE buttons to select the track you want to clear.
- > Press SHIFT + CLEAR
- > Use the encoder to select "clear [track]?" on the display.
- > Push CLEAR again to confirm or release the SHIFT button to abort.

## 7 > OPERATION MODES

There are different modes for different tasks. Voice editing, performance or generating patterns.

The main modes are accessible with the 4 MODE buttons. Further modes and menus are available as alternate SHIFT functions on the SEQUENCER buttons.

### 7.1. VOICE EDIT MODE

The voice edit mode is used to modify the sound parameters and to do basic pattern editing.

- 1 The parameters of the selected synthesis page are shown on the display.
- 2 Knobs are used to edit the visible parameters.
- 6 The SEQUENCER buttons are used to set and remove steps of the current track.
- 9 The BAR buttons can be used to edit more than 16 steps. Up to 4 bars, each with 16 steps, can be used per pattern.
- 10 The VOICE buttons select the voice and sequencer track to edit. Together with the SHIFT button they are used to mute single voices.
- 12 The SELECT buttons are used to select the active synthesis page (oscillator, envelope, mixer...).



## PATTERN EDITING

The 16 SEQUENCER buttons are used to set and remove steps in the selected pattern. Each button is a 16th note from a 4/4 bar. If a step is set, the LED in the button is lit.

## SOUND EDITING

- > The 7 VOICE buttons [10] select the active voice, which is indicated by a lit LED.
- > The parameters of the voice are divided into several pages which can be selected using the 8 SELECT buttons [12].
- > Each voice type has its own set of parameters, but the overall page structure is the same for all voices.
- > Parameters in the display can be edited using the 4 encoders below.

## Parameter editing

As an example lets take a look at the filter page:

Frq	res	typ	drv
32	120	LP	0

- > To change the frequency of the filter of voice 3
- > Press ' VOICE Button 3' to select the voice.
- > Press ' SELECT button 6' to show the filter page.
- > Use the first knob to adjust the 'frq' parameter.

## CLEAR KIT / INIT SOUND

- If you want to start over with a fresh sound, you can use the 'clear kit' option.
- > Press and hold SHIFT + COPY = CLEAR and use the encoder to select "Clear [kit]?"
  - > Confirm the selection by pushing the CLEAR button again. The kit will now revert back to the init sound.

## 7.2. STEP (EDIT) MODE

This Mode is used to edit the step parameters volume, note value and probability as well as automation data. You can enter the step edit mode by hitting the VOICE button again, when you are in voice mode. It is indicated by a blinking voice LED.

**The VOICE button will toggle between voice and step mode.**



### Did you know?

If you have a MIDI keyboard connected, you can enter NOTE values for a step via MIDI in Step Edit Mode.

## STEP PARAMETER EDITING

Step parameters consist of note value, velocity, probability and the parameter automation. You can find more information in the step parameter section of the manual.

- > Select the step you want to edit using the SEQUENCER buttons.
- > The selected step button starts to blink.
- > The display will show the step parameters.
- > Use the knobs and encoder to change parameters.
- > A flashing LED indicates the selected step on the sequencer buttons.
- > You can select another step using the 16 SEQUENCER buttons.

## 7.3. PERFORMANCE MODE

This mode is designed to jam live. You can trigger manual rolls for each voice and access the morph and global sample rate FX. Voice editing is not possible in this mode.

### BASIC PERFORMANCE MENU

In performance mode the display shows a set of 5 parameters.

Displayed name	Name	Description
bpm	Tempo	Adjust the tempo of the sequencer. Setting it to 0 or 'Ext' will enable slave mode to sync the LXR to external MIDI or clock sources.
rol	Manual roll rate	Adjust the trigger rate for manual roll function of sequencer buttons 1 to 7.
mrp	Morph amount	Ratio between the original sound and the morph target.
sr	Global samplerate	A global sample rate reduction effect.
shu	Shuffle amount	Sets the amount of global shuffle.

## MANUAL ROLL

The first 7 sequencer buttons trigger a manual roll for each corresponding voice. The roll rate can be adjusted in the menu using the 'rol' parameter. Rolls are recorded to the pattern when the recording mode is active.

## MORPH

The morph feature allows you to morph from one preset sound to another. You can load any preset from the SD card as a morph target. The Morph amount value controls the ratio between the original and the target sound. As the morph parameter is increased, the current sound is gradually transformed into the selected morph target sound.

For an explanation how to load a morph target, see the [LOAD AND SAVE MODE](#) section of this chapter.

## SHUFFLE

The shuffle function will shift the position of every other 16th note  
The original pattern timing looks like this:

| **X** x x x **X** x x x **X** x x x **X** x x x |

With increased shuffle every other 16th note is delayed, thus shifted in the direction of the next 16th note:

| **X** xx **xX** xx **xX** xx **xX** xx x |

## 7.4 .LOADING AND SAVING

When the LXR is turned on, a project is automatically loaded from the SD card to the machine's memory.

After this initial load, all changes made are temporary. If another kit is selected, all changes to the current kit are lost. If a pattern is changed, all changes to the current pattern are lost.

To make these changes permanent for the current session, you have to manually save the kit, pattern or song to commit them to the LXR's memory. To make them persistent over reboots, you have to save the project back to the SD card.



**Every change, even when saved to the LXR's RAM, will be lost once power is turned off, if the project was not written back to the SD card! So always remember to hit the save project button at the end of your session.**

The LOAD and SAVE buttons, together with the KIT, MORPH, SONG, PROJECT and PATTERN buttons from the sequencer are used to enter the load/save menu.

#### DISPLAY DESCRIPTION

The load and save menu is basically the same for all datatypes:

Load: Sound  
[1] Name

- > The first row of the display gives information about the active mode (load or save) as well as the selected datatype (Kit, Pattern, Project ...) that will be processed.
- > The second row chooses the active preset number and displays the name of the selected preset.
- > You confirm the selection by pushing the encoder button.

#### MENU NAVIGATION

- > Use the encoder to navigate through the menu.
- > Push the encoder to confirm your selection.

#### Quick naming scheme

To speed up the name entry on the save page you can also use the knobs below the display. If the cursor is in the name area the knobs have the following functions:

- > The first knob selects the cursor position.
- > The second knob switches between upper and lower case letters.
- > The third knob scrolls through the available default ASCII characters.

#### KITS

Kits are sound presets and contain all synthesis parameters of the 6 voices. A project contains 64 kits.

#### Loading

- > Press LOAD + KIT
- > Select a new kit with the encoder.
- > To load the selected kit push the encoder.
- > The kit sound will play immediately.
- > Unsaved changes to the previous kit are lost.

#### Saving

- > Press SAVE + KIT
- > Select the preset number you want to save your kit to.
- > Push the encoder.
- > You will be asked: "Edit Name? [y/N]"
- > If you don't want to change the name, push the encoder and your kit is saved.
  
- > If you want to change the name, use the encoder to navigate to [Y/n] and push it.
- > Navigate to the letters of the name.
- > You can change the letters if you push the encoder and turn it or refer to the QUICK NAMING SCHEME
- > If you are happy with the name, navigate the cursor to the 'ok' button and push the encoder down to save the kit.

## MORPH KITS

A morph kit is a normal kit that is loaded as morph target. Any kit can be loaded as a morph target.

### Loading

> Press LOAD + MORPH

> Select the preset number of the kit you want to load.

> Push the encoder.

> The morph sound is loaded.

> Please note that you won't hear any change if the morph parameter value is set to zero.

> Use the morph parameter on the performance page to morph the current kit into the loaded morph kit.

### Saving

You can also save the resulting sounds from morph operations. Just press the SAVE + MORPH buttons and save the sound as a new kit. Instead of the original sound, the currently playing mixture of the 2 presets will be saved.



#### Did you know?

If morphing arbitrary presets is too drastic for you, try modifying your favourite pattern just a little bit and save it to a new location. Now you can control all tweaked parameters at once!

## SONGS

The process to load and save songs is the same as described for the kits. Just use the button combo Press LOAD + SONG or SAVE + SONG instead.

## PATTERNS

Patterns are a special case as they have no name. Loading and saving is done in a similar fashion like changing patterns in pattern mode.

### Loading

> Press LOAD + PATTERN

> The screen will show "Select Pattern, Current: x"

> Now you can use the SEQUENCER and BAR buttons to select the pattern to load.

> If the sequencer is playing, the new pattern will start after the current pattern has finished playing.

### Saving

> Press SAVE + PATTERN

> The screen will show "Save Pattern, Current: x"

> Now you can use the SEQUENCER and BAR buttons to select where to save the pattern.

> As soon as you press the SEQUENCER button, the display will show "success!" and the pattern is saved

## PROJECT

The process to load and save project is the same as described for the kits. Just use the button combo Press LOAD + PROJECT or SAVE + PROJECT instead.

Where Projects are special is in regard to the place where they are saved. All previous datatypes are loaded from and saved to the non persistent RAM region where the project data is located. Projects however are saved to the memory card and are the only way to save kits, songs and patterns so they will be restored after a power cycle. Projects are containers that are a collection of Kits, Patterns, Songs and settings.

## 7.5. PATTERN GENERATOR MODE

The pattern generator provides an easy way to generate interesting poly rhythms on the fly. You just have to set the desired pattern length and the number of active steps to generate a new pattern using the euclidean algorithm.<sup>1</sup>

## MENU LOCATION

To start the pattern generator press the SHIFT + PERF buttons. A flashing PERF button LED indicates that the pattern generator mode is active. The display will show the pattern generator menu.

## PATTERN GENERATOR MENU

The pattern generator page offers the following parameters

Displayed name	Name	Description
len	Track Length	The length of the track in 1/16 notes. Each track can have a different length.
stp	Number of Steps	The number of active steps in the pattern.
rot	Rotation	Step wise shift the pattern to the left or right.
mrp	Morph	Morph parameter also found on the performance page.

## GENERATING PATTERNS

Generating a new pattern is fairly simple.

- > The generator will always modify a single track from the pattern.
- > The active track can be chosen with the 7 VOICE buttons.
- > As soon as you either change the 'length' or the 'number of steps' parameter, a new pattern will be generated on the track.



### ATTENTION!!!

Existing pattern data will be overwritten. However, if you don't save the pattern and reload it from the pattern menu, the original pattern will be restored.

## 7.6. GLOBAL SETTINGS MENU

The settings menu contains the global configuration of the synth. Global settings are saved with the project.

### MENU LOCATION

- > Press the SHIFT + CONFIG (Seq. 12) buttons.
- > The CONFIG button starts to flash to indicate that the global settings menu is active.

### MENU OPTIONS

Displayed name	Name	Description
bpm	Tempo in BPM	The tempo of the internal clock. If set to zero the external MIDI clock sync is active.
ch	Global MIDI Channel	The global MIDI channel is used for MIDI control that effects all tracks. <ul style="list-style-type: none"><li>&gt; Listen for program change messages</li><li>&gt; Listen for CC messages.</li><li>&gt; MIDI note messages received on the global channel, are routed to the current selected voice.</li></ul>
mtx	Transmitted MIDI Filtering	P - Program Change, C - Control Change, R- Realtime start/stop/clock, N - Note on/off.  If a letter is shown, the midi message in that category will be transmitted.  If set to off, nothing is sent, and if set to all everything is sent.

mrx	Received MIDI Filtering	<p>P - Program Change, C - Control Change, R-Realtime start/stop/clock, N - Note on/off.</p> <p>If a letter is shown, the MIDI message in that category will be received.</p> <p>If set to off, nothing is received, and if set to all everything is received.</p>
mrt	MIDI Routing	<p>Off - no routing.</p> <p>U2M - USB MIDI is routed to the midi out port.</p> <p>M2M - MIDI received on MIDI in port is routed to the MIDI out port.</p> <p>A2M - both USB and MIDI are routed to the MIDI out port.</p> <p>M2U - the MIDI input port is routed to the USB output port.</p>
ssv	Screensaver	Turn the screensaver on or off.
flw	Pattern follow	If active, the view follows the playback position on multi bar patterns.
kcm	Kit change mode	When you save a pattern, the currently used kit is saved with the pattern. When Pattern change mode is set to 'Auto' the saved kit is loaded automatically when a pattern is changed. This setting is saved per project!
cki	Clock In PPQ	Resolution of the analogue clock input.
cko	Clock out PPQ	Resolution of the analogue clock output.

## SCREENSAVER

The display provided with the kit is an OLED display. To expand the lifetime of the OLED display and to avoid burn in, the firmware provides a screensaver for the display. After no control is touched for some minutes, the display will show the screensaver. As soon as any control is touched, the display will show the menu again. The screensaver can be deactivated in the settings menu.

## LOADING AND SAVING OF GLOBAL SETTINGS

The global settings are saved together with the project. Whenever you load or save a project, the global settings are loaded/saved as well.

## 7.7. PATTERN MENU

The pattern menu is used to change the playing pattern. It is accessed by pushing SHIFT + PATTERN (Seq. 16)

The display will show

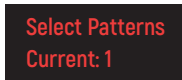

to indicate the active "select pattern" mode and the currently playing pattern.

## CHANGING THE PATTERN

You can use the 16 SEQUENCER buttons together with the BAR buttons to change the pattern.

When a SEQUENCER button is pressed, it starts flashing and at the end of the currently playing pattern, the selected pattern begins to play. The button LED changes to lit and the "current:" display will indicate the new pattern number.

If the sequencer is stopped, the pattern will change immediately.

The BAR buttons are used to select the pattern group for the 16 sequencer buttons (1-16, 17-32, 33-48 and 49-64)



## 7.8. SONG MODE

The song mode allows you to arrange up to 64 patterns to play after each other to arrange them into a song.

### EDITING SONGS

To enter song mode, press SHIFT + SONG [Seq. 10]

The song mode page will show the following menu on screen

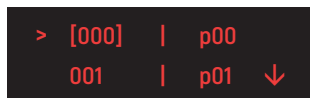

> The first column shows the slot number. These are just the numbers from 0 to 63.

> The square brackets highlight the current cursor selection for the encoder.

> If in the first column, the encoder will scroll the whole list up or down.

> In the second column, the encoder will select the pattern to play.

> Push the encoder to change between the 2 columns.

> An arrow on the right side just indicates that the list continues in this direction offscreen.

### USING THE SEQUENCER BUTTONS TO ADD PATTERNS

A convenient way to add patterns to the song table is to use the SEQUENCER buttons.

Instead of using the encoder, you can just push the corresponding SEQUENCER button to select a pattern for the active row. Quite similar to the pattern change menu in pattern mode.

The BAR buttons are used as usual to view the 4 different pattern groups.

### INSERTING AN REMOVING LINES

To insert a line into the song table, just push the COPY button. It will insert a copy of the highlighted pattern in the slot below and shift the following patterns down by one.

To delete a line from the song table, use the clear function by pressing

SHIFT + COPY = CLEAR

This will delete the currently selected row.

### SPECIAL PATTERNS

Besides the normal pattern numbers from p00 to p63, you can set the second column to 'END' and LOOP.

#### END

The end marker tells the sequencer that the song ends here. When reaching a slot with the end marker, the sequencer will stop playback.

#### LOOP

The loop marker tells the sequencer to start the song again from the beginning. So if you have the following list in the song menu:

> p00

> p01

> LOOP

the sequencer will play p00, p01, p00, p01... indefinitely.

### PLAYING A SONG

To play the loaded song, hit SHIFT + PLAY.

The LXR will now play the pattern chain defined on the song mode page, even if you change menus or change to view the performance or voice modes.



Please be aware, that temporary changes you make to the pattern are lost whenever the song mode changes the pattern. So editing in song mode is not advisable, since automatic pattern changes will occur frequently in this mode!

## 7.9. FX MODE

The LXR provides a digital FX processor. Only 1 effect can be used at a time. Currently there are 4 FX available: Drive, Ringmodulator, Compressor and Delay. You can use the FX processor by setting the output routing on the mixer page to "FX". So the voice will be routed to the FX bus before going to the output. You can select which of the voices will be processed by the FX processor. Selected FX and its settings are saved within the KIT so think of the FX as more of a sound design insert block rather than master send FX.

### MENU LOCATION

The FX menu is accessed by pushing SHIFT + FX.

### DRIVE

The drive FX is a collection of different distortion algorithms. It offers 3 different types of saturation. In contrast to the drive parameter of the single voice filter and mixer pages, this FX processes all signals in a single distortion unit. This leads to interesting intermodulation between the input signals.

#### Drive Types

The 4th parameter "type" selects the drive algorithm to use.

- > Tub – Adds tube Saturation.
- > Fld – A wavefolder distortion.
- > Clp – A rodent inspired hardclip pedal emulation.

#### Parameters

Displayed name	Name	Description
typ	FX Type	Drive
out	Output routing	Selects the Audio output the FX signal is mixed to.
d/w	Dry / Wet ratio	Mixing ratio between the original and the FX signal.

drv	Drive strength	Input gain of the distortion unit.		
col	Colour	Tube	Fold	Clip
		Bias	Offset	Feedback
ton	Tone	Tone Control Filter.		
vol	Volume	Output volume of the distortion.		



The feedback parameter of the Clip processor will generate a tone when no input is present. This is normal behaviour, as the effect is quite similar to the feedback sound a microphone produces in front of a speaker. While a drum pattern is playing, it gives nice intermodulation, but without input, a clean tone is produced. Just pull down the master volume if you stop the sequencer when you are using full feedback.

### RINGMODULATOR

The ringmodulator multiplies the input signal with a second oscillator signal. Ever wanted to hear a Dalek beatboxing? Then the ringmod is your friend!

#### Parameters

Displayed name	Name	Description
typ	FX Type	Ring.
out	Output routing	Selects the Audio output the FX signal is mixed to.
d/w	Dry / Wet ratio	Mixing ratio between the original and the FX signal.
wav	Waveform	Modulation Waveform.
frq	Frequency	Frequency of the modulation waveform.

## COMPRESSOR

A compressor is a dynamic processor that is able to reduce the volume of loud sounds and boost the volume of quiet sounds, thus reducing the dynamic range of the signal.

### Parameters

Displayed name	Name	Description
typ	FX Type	Compressor.
out	Output routing	Selects the Audio output the FX signal is mixed to.
d/w	Dry / Wet ratio	Mixing ratio between the original and the FX signal.
rat	Compression ratio	1:1 up to 8:1 in dB. Strength of the compression. For example a ratio of 2:1 will attenuate the volume of a signal 2dB above the threshold down to 1dB above the threshold.
atk	Attack	Time it takes for the compressor to kick in. 0.3 to 100ms range.
dec	Decay	Time it takes to return to normal gain, after the input falls below the threshold. 25 to 200ms range.
tre	Threshold	The threshold sets the level at which the compression effect sets in. -96 to 0dB.
gai	Makeup Gain	Compression lowers the volume. Use the output gain to make up for the difference.

## DELAY

Straight forward delay FX. Not much to say here. It's a classic!  
Try using the range control for very short delay times and LFO modulation to get some flanger action going!

### Parameters

Displayed name	Name	Description
typ	FX Type	Delay.
out	Output routing	Selects the Audio output the FX signal is mixed to.
d/w	Dry / Wet ratio	Mixing ratio between the original and the FX signal.
typ	Delay type	Currently only 1 delay available.
tim	Delay time	Adjust the delay time in the range specified by the range parameter.
rng	Time range	Sets the range for the delay time dial. The low range is 1ms to 20ms The high range is 20ms to 0.7sec.
ton	Tone	Frequency of the lowpass filter in the feedback path.
fbk	Feedback	Controls the number of repeats.

## 7.10. RELOAD BUTTON

Reload is a handy little function, that allows you to revert the current kit and pattern back to its original state. If you tweaked the kit during a live performance and want to revert all changes immediately, push SHIFT + RELOAD.

# 8 > OPERATION MODES

In this chapter we will take a closer look at the synth modules used in the different voices.

## 8.1. OSCILLATOR

The oscillators provide 6 different waveforms:

- > Sine
- > Triangle
- > Saw
- > Rectangle
- > Noise
- > PWM

The waveforms are classic analogue waveforms realized using bandlimited wavetable oscillators.

## 8.2. FILTER

The filter is a 2 pole [12dB] state variable filter (SVF). It's used to shape the harmonic content of the sound. For example a hihat sound consists of high frequencies and no low frequencies, so you want to use a highpass filter. A clap has lots of mid sounds, here a bandpass filter is useful.

There are 3 parameters that control the filter response. Frequency, resonance and drive.

### FREQUENCY

The frequency determines the operating point of the filter in the spectrum. For example a low pass filter will cut off all frequencies above its set cutoff frequency (all frequencies below it pass the filter unaltered – hence the name).

### RESONANCE

The resonance controls the feedback path of the filter. With higher resonance settings the frequencies around the operating point (i.e. the set frequency) will be amplified more and more.

It becomes clear if we look at the filter amplitude response plots in the next section.

### DRIVE

Controls how 'hot' the filter is driven. More drive yields more distortion. In the normal operating range, when drive is set to 0, the filter is quite clean and nearly linear. With higher input levels/drive settings, a soft clipper as well as the slew rate limit of the integrators comes into effect. Low settings will only affect the resonance peaks, higher settings will distort the whole signal. Since the soft clipper is scaling down excessive peaks in the signal, the audible resonance is reduced with higher drive settings.

### FILTER TYPES

There are several different filter types available, each with its own characteristics. Let's have a closer look at each one of them. The filters are plotted with 3 different resonance settings. No resonance, medium and high. The cutoff frequency is the same in every plot and marked by the vertical dashed line. The x axis shows the frequency from 0Hz to 22kHz, the y axis shows the gain for the specific frequency – both on a logarithmic scale.

### Lowpass

The lowpass filter removes high frequencies from the signal. All frequencies above the cutoff frequency are reduced gradually.

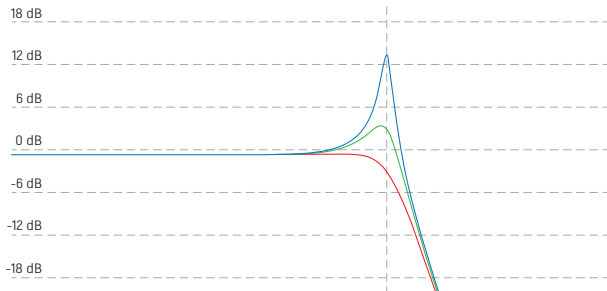

### Highpass

The highpass filter removes low frequencies from the signal. All frequencies below the cutoff frequency are reduced gradually.

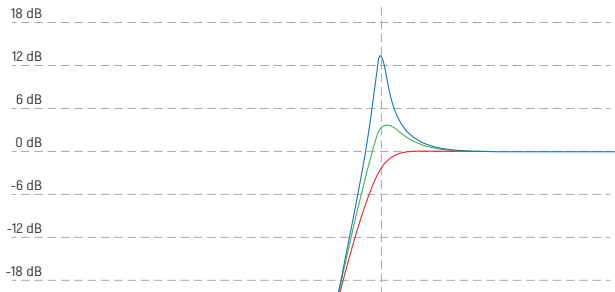

### Bandpass

The bandpass filter removes frequencies above and below the set cutoff frequency.

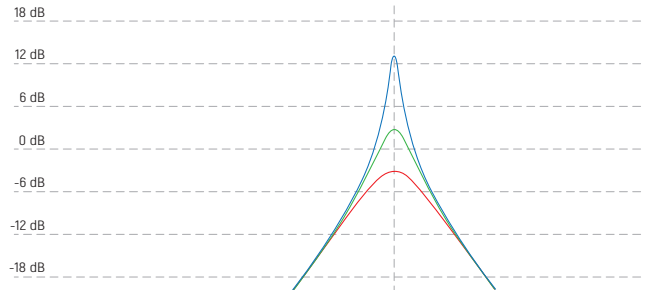

### Unit gain bandpass

The unit gain bandpass is a scaled version of the normal bandpass filter. The gain is always adjusted to have its maximum around 0dB gain. Unlike the normal bandpass, where the resonance controls the amplitude of the peak gain, it controls the width of the passband.



### Notch

The notch filter removes frequencies around the set filter frequency. Again, the resonance controls the width of the stopband.

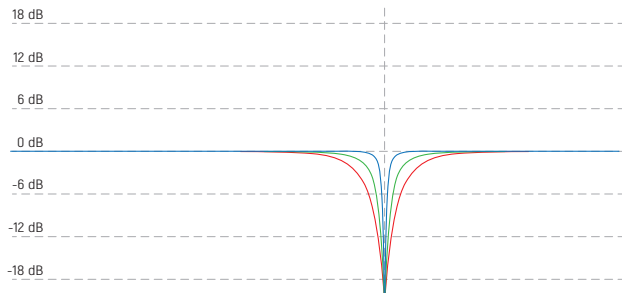

### Peak

The peak filter amplifies frequencies around the filter frequency, but lets the other frequencies pass nearly unaltered. The resonance controls the amount of amplification.

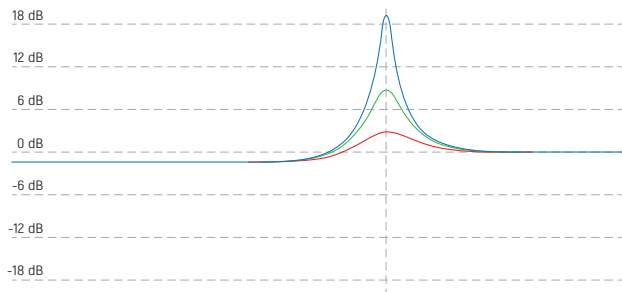

### LP2 Type

This type is a special case. It replaces the SVF model with a simpler implementation of the SVF topology with much more digital resonance. Use it for those screaming acid sounds!

## 8.3. ENVELOPES

Envelopes are used to generate a varying control signal that can control other synthesis parameters. Whenever a voice is triggered, the envelope is restarted. The signal rises with the speed selected by the attack setting until it reaches the maximum amplitude. Then it will fall back down to zero, with the speed set by the decay parameter.

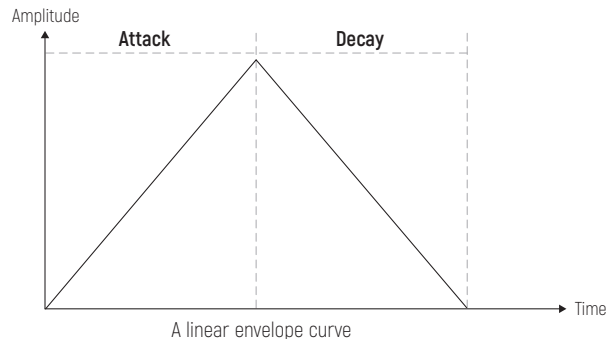

### ATTACK/DECAY TIMES

These 2 parameters control the duration of the attack and decay stage of the envelope. A higher value equals longer time. If the attack time is set to zero, the envelope will directly start in the decay stage.

## SLOPE

The slope parameter controls the shape of the generated curve. A setting of 63 will give you a linear envelope as seen above. Lower settings will result in an exponential curve, higher values result in a logarithmic curve.

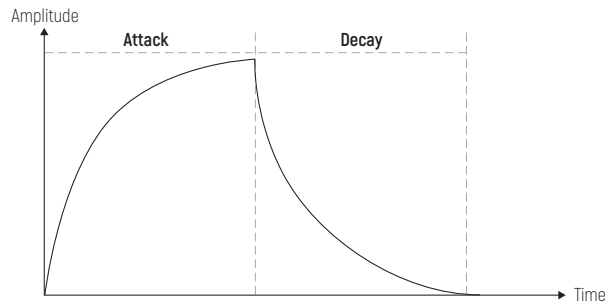

Curve with a low slope setting. Exponential decay stage.

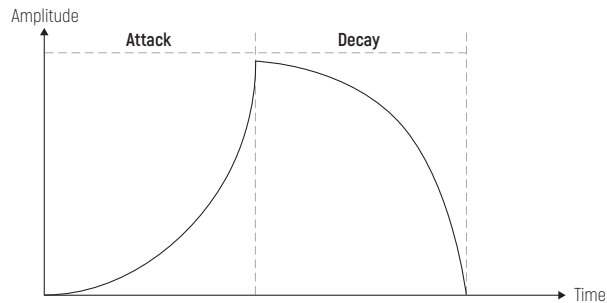

Curve with a high slope setting. Logarithmic decay stage.

## REPEAT

A special feature of the envelope to simulate claps and other sounds with a fuzzy/rattling attack.

If the repeat count is set to a value greater than zero, the envelope is in repeat mode.

The slow onset of the attack stage is replaced by the repeat stage in which the envelope is retriggered rapidly. The attack parameter controls the duration of the complete repeat phase.

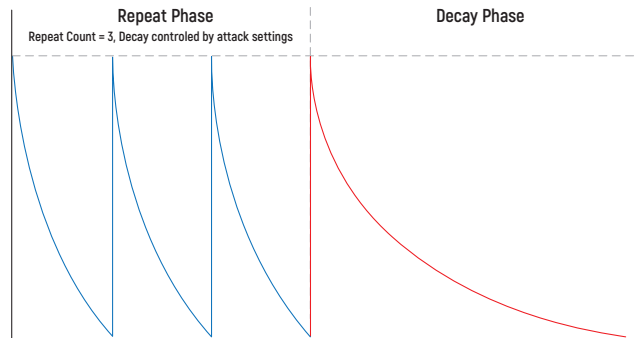

## 8.4. TRANSIENT GENERATOR

The transient generator is used to shape the beginning of a sound. Since the perception of sounds is heavily influenced by their first few milliseconds, this feature is useful to spice up or vary the sound character of an instrument.

There are different modes the transient generator uses to shape the attack.

## SNAPPY MODE

The snappy mode is the first entry in the selection list, shown in the menu as 'Snp'. To make the attack of the sound more 'snappy' an additional pitch envelope is used.

- > The volume parameter controls the modulation depth.
- > The frequency parameter controls the decay time.

The envelope is quite fast and modulates the pitch of the oscillators resulting in a nice, controllable snap or click sound.

## OFFSET MODE

The second entry is the offset mode with the menu name 'Off'. In this mode, the start phase of the oscillators can be adjusted with the volume parameter. The frequency parameter has no effect. If the volume is set to zero, the oscillators will be reset to a zero crossing of the waveform on each trigger. If the volume parameter is set to its maximum value, the waveform will start in the position with the highest amplitude, generating a loud pop. This results in the volume parameter controlling the intensity of the initial pop.

## SAMPLE MODE

A short transient sample is mixed to the sound. They are short (~50ms) 8-bit ROM samples that are played as a one shot whenever the sound is triggered. Different samples can be selected.

## PARAMETERS

The parameters of the transient generator include the PCM waveform to use, the playback frequency and the volume. The ROM samples can't be changed by the user on the fly. They are hardcoded into the firmware.

A list of the included samples:

Displayed name	Name	Description
Snp	Snappy Mode	
Off	Offset Mode	

## Transient Samples

Displayed name	Name	Description
Clk	Click	
Ck2	Click 2	
Tik	Tick	Some kind of tick sound <sup>2</sup>
Kik	Acoustic kick	An acoustic kick drum <sup>3</sup>
Rim	Rim shot	A rim shot sound <sup>4</sup>
Drp	Drip	A dripping sound made by a human being <sup>5</sup>
Hat	Tick	Some kind of tick sound <sup>1</sup>
Tik	Hat	Sampled off of Zildjian A-Custom Hi-Hats <sup>6</sup>
Clp	Clap	808 clap <sup>7</sup>
Ki2	Kick 2	A kick sample
Sna	Snare	A snare sample
Tom	Tom	A tom sample (sort of)
Sp2	Snap	A finger snap



## 8.5. SAMPLE RATE REDUCTION

The sample rate reducer can gradually reduce the sample rate from 44kHz to zero. Reducing the sample rate will give more of a lo-fi sound. The more it is reduced, the more odd harmonics will be added to the sound as overtones are folded down at the Nyquist frequency until the sound is totally destroyed.

## 8.6. DISTORTION

The distortion unit on the mixer page is a variable waveshaper. It can be set from no distortion to soft saturation, all they way up to hard clipping.

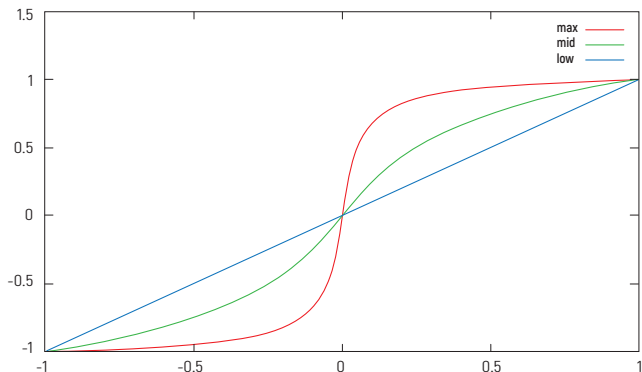

## 8.7. LFO

Each voice has a low frequency oscillator. They are basically the same as the audio oscillators, but run at a lower maximum rate.

Unlike the audio oscillators you can not hear the LFOs directly. They are used to alter other parameter values over time. For example if you want the filter of a voice to slowly open and close again, you can use a sine lfo to modulate the filter cutoff.

### SETTING UP MODULATIONS

The modulation target is selected on the second page of the LFO menu.

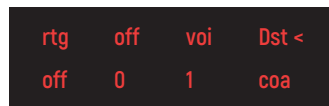

The target selection consists of the two parameters 'Voice' and 'Destination'. When the voice parameter is changed, the list of available destinations will show all available parameters of the selected voice.

The frequency of the LFO can be synced to the sequencer clock. So if you set the sync value to 1/4 note, the LFO waveform will cycle exactly 4 times in one bar. While sync is active the frequency parameter will be ignored.



### Did you know?

You can use the LFO as an additional envelope using the retrigger feature. If set to the same voice as the modulation destination, the LFO will restart on every played note. You just have to set the LFO frequency so that one cycle of the LFO is slightly longer than the amplitude envelope, so it won't start a new cycle while the note is still playing. Great for filter decay envelopes on juicy synth bass sounds!

## 8.8. VELOCITY MODULATION

The note on velocity can be used as a modulation source and is an important tool to bring some life to your static patches. The velocity can modulate 2 destinations

- > The velocity can modulate the voice volume.
- > Additionally it can modulate any parameter of the voice.

Especially when using external MIDI gear like keyboards or drum pads the velocity modulation is quite fun. If you don't use external input devices and are only using the internal sequencer, the velocity for each step can be set in the [STEP PARAMETER MENU](#).



### Did you know?

By default the velocity is modulating the voice volume. This hard wired connection can be turned off in the modulation menu with the 'Vol' on/off parameter.

By deactivating the volume modulation you can use the velocity modulation as a 3rd automation track.

## 8.9. OUTPUT ROUTING

Each voice can be freely routed to the 4 different output jacks. They act either as 4 individual mono outs (the pan parameter has no effect) or as 2 pairs of stereo outputs. There is an additional FX bus available as a routing target as well. Have a look at the FX section of the manual for more info.



### Did you know?

The synth detects if a cable is inserted into the jack. If you have a patch where a voice is routed to an unconnected output, it will be played on the nearest connected output instead.

## 9 > MIDI

The synthesizer has 2 MIDI interfaces. A standard serial interface using DIN connectors, as well as a MIDI USB interface to be used with a computer. Both interfaces provide an I/O pair.

### 9.1. MIDI CHANNEL

You can set a global MIDI channel and a per-voice MIDI channel for different use cases.

### 9.2. MIDI ROUTING (MIDI SOFT THRU)

You can route MIDI messages from input to output. This is set in the global menu under "mrt". There are 6 possible values:

- > off - no routing.
- > U2M - USB MIDI is routed to the MIDI OUT port.
- > M2M - MIDI received from the MIDI IN port is routed to the MIDI OUT port.
- > A2M - both USB and MIDI are routed to the MIDI OUT port.
- > M2U - the MIDI input port is routed to the USB output port.
- > M2A - MIDI received from the MIDI IN port is routed to both the MIDI output and the USB output.

### 9.3. MIDI FILTERING

You can filter messages from being transmitted or received. Transmit(Tx) is independent of receive(Rx). There are four categories of messages that can be individually configured:

- > Program Change (P)
- > Control Change (C)
- > Realtime start/stop/clock (R)
- > Note on/off (N).

These are set in the global menu under mtX and mrX (transmit and receive respectively). Combinations of letters are shown. If a letter is shown, the midi message in that category will be transmitted or received. If set to off, nothing is sent/received, and if set to all everything is sent/received. This has nothing to do with MIDI routing which works the same way regardless of filter.

## 9.4. MIDI SYNC

The LXR can be synced to external gear using MIDI clock signals. To do so, set the BPM parameter in the settings menu to '0'. The LXR will now sync it's tempo to incoming MIDI clocks.

While synced to external gear the start/stop button has no function. The synth will listen for MIDI start/stop signals instead.

While not in MIDI slave mode, the LXR will send out its internal clock via MIDI clock messages to both the USB and MIDI outputs. This way, the LXR can act as a MIDI master and sync other devices to its clock. MIDI start/stop messages will be sent when you start or stop the sequencer.

## 9.5. RECORD INCOMING MIDI

You can play all voices with external MIDI gear (drumpads, keyboard...)

If the record mode is active, the played MIDI notes are directly recorded into the corresponding patterns. The MIDI notes to which the voices react can be selected on their "Mixer" page in the menu. These MIDI settings are saved globally for the project and not in each kit.

### RECORDING MELODIES

If you set the MIDI note to "ANY" on the voice mixer page, you enable tonal play. The voice can now be played "melodically" from external MIDI keyboards. Note values will be recorded to the active track, if the record function is active.



#### Did you know?

You can clear recorded notes on the fly in recording mode, if you press SHIFT + CLEAR. The notes will be deleted at the playback position while the keys are held.

## 9.6. TRANSMITTING SEQUENCER DATA TO THE MIDI OUT

MIDI notes will be sent out according to the track's MIDI channel and note settings when not turned off in the MIDI filter options.

## 9.7. MIDI CC LIST

Parameters can be remote controlled with MIDI CC messages.

CC	Function	Voice
0	-	-
1	-	-
2	Waveform Osc 1	1
3	Waveform Osc 1	2
4	Waveform Osc 1	3
5	Waveform Osc 1	4
6	NRPN data entry	-
7	Waveform Osc 1	5
8	Waveform Osc 1	6
9	Coarse tune Osc 1	1
10	Fine tune Osc 1	1
11	Coarse tune Osc 1	2
12	Fine tune Osc 1	2
13	Coarse tune Osc 1	3
14	Fine tune Osc 1	3
15	Coarse tune Osc 1	4
16	Fine tune Osc 1	4
17	Coarse tune Osc 1	5
18	Fine tune Osc 1	5
19	Coarse tune Osc 1	6
20	Fine tune Osc 1	6
21	Waveform mod. OSC	1
22	Waveform mod. OSC	2
23	Waveform mod. OSC	3
24	Waveform mod. Osc 1	5
25	Waveform mod. Osc 2	5
26	Waveform mod. Osc 1	6
27	Waveform mod. Osc 2	6

CC	Function	Voice
28	Noise frequency	4
29	Mix osc/noise	4
30	Coarse tune mod. Osc 1	5
31	Coarse tune mod. Osc 2	5
32	Gain mod. Osc 1	5
33	Gain mod. Osc 2	5
34	Coarse tune mod. Osc 1	6
35	Coarse tune mod. Osc 2	6
36	Gain mod. Osc 1	6
37	Gain mod. Osc 2	6
38	Filter frequency	1
39	Filter frequency	2
40	Filter frequency	3
41	Filter frequency	4
42	Filter frequency	5
43	Filter frequency	6
44	Filter resonance	1
45	Filter resonance	2
46	Filter resonance	3
47	Filter resonance	4
48	Filter resonance	5
49	Filter resonance	6
50	Volume envelope attack	1
51	Volume envelope decay	1
52	Volume envelope attack	2
53	Volume envelope decay	2
54	Volume envelope attack	3
55	Volume envelope decay	3

CC	Function	Voice
56	Volume envelope attack	4
57	Volume envelope decay	4
58	Volume envelope attack	5
59	Volume envelope decay	5
60	Volume envelope attack	6
61	Closed Hihat decay time	6
62	Open Hihat decay time	6
63	Volume envelope slope	1
64	Volume envelope slope	2
65	Volume envelope slope	3
66	Volume EG slope	4
67	Volume EG slope	5
68	Volume EG slope	6
69	Volume EG repeat count	4
70	Volume EG repeat count	5
71	Mod. Envelope decay	1
72	Mod. Envelope decay	2
73	Mod. Envelope decay	3
74	Mod. Envelope decay	4
75	Envelope mod. amount	1
76	Envelope mod. amount	2
77	Envelope mod. amount	3
78	Envelope mod. amount	4
79	Mod. Envelope slope	1
80	Mod. Envelope slope	2
81	Mod. Envelope slope	3
82	Mod. Envelope slope	4
83	FM amount	1

CC	Function	Voice
84	FM frequency	1
85	FM amount	2
86	FM frequency	2
87	FM amount	3
88	FM frequency	3
89	Voice volume	1
90	Voice volume	2
91	Voice volume	3
92	Voice volume	4
93	Voice volume	5
94	Voice volume	6
95	Voice pan	1
96	Voice pan	2
97	Voice pan	3
98	NRPN fine	
99	NRPN coarse	
100	Voice pan	4
101	Voice pan	5
102	Voice pan	6
103	Distortion	1
104	Distortion	2
105	Distortion	3
106	Distortion	4
107	Distortion	5
108	Distortion	6
109	Decimation	1
110	Decimation	2
111	Decimation	3

CC	Function	Voice
112	Decimation	4
113	Decimation	5
114	Decimation	6
115	Decimation	all
116	LFO freq	1
117	LFO freq	2
118	LFO freq	3
119	LFO freq	4
120	LFO freq	5
121	LFO freq	6
122	LFO amount	1
123	LFO amount	2
124	LFO amount	3
125	LFO amount	4
126	LFO amount	5
127	LFO amount	6

## 9.8. MIDI NRPN LIST

Since there are more than 127 parameters in the LXR, some parameters have to be controlled using NRPN messages.

NRPN Nr.	Function	Voice
0	Filter drive	1
1	Filter drive	2
2	Filter drive	3
3	Filter drive	4
4	Filter drive	5
5	Filter drive	6
6	Mix/Mod select	1
7	Mix/Mod select	2
8	Mix/Mod select	3
9	Velocity volume mod. on/off	1
10	Velocity volume mod. on/off	2
11	Velocity volume mod. on/off	3
12	Velocity volume mod. on/off	4
13	Velocity volume mod. on/off	5
14	Velocity volume mod. on/off	6
15	Velocity mod. amount	1
16	Velocity mod. amount	2
17	Velocity mod. amount	3
18	Velocity mod. amount	4
19	Velocity mod. amount	5
20	Velocity mod. amount	6
21	Velocity mod. destination	1

NRPN Nr.	Function	Voice
22	Velocity mod. destination	2
23	Velocity mod. destination	3
24	Velocity mod. destination	4
25	Velocity mod. destination	5
26	Velocity mod. destination	6
27	LFO waveform	1
28	LFO waveform	2
29	LFO waveform	3
30	LFO waveform	4
31	LFO waveform	5
32	LFO waveform	6
33	LFO target voice	1
34	LFO target voice	2
35	LFO target voice	3
36	LFO target voice	4
37	LFO target voice	5
38	LFO target voice	6
39	LFO target	1
40	LFO target	2
41	LFO target	3
42	LFO target	4
43	LFO target	5
44	LFO target	6
45	LFO retrigger	1
46	LFO retrigger	2
47	LFO retrigger	3
48	LFO retrigger	4
49	LFO retrigger	5

<b>NRPN Nr.</b>	<b>Function</b>	<b>Voice</b>
50	LFO retrigger	6
51	LFO sync	1
52	LFO sync	2
53	LFO sync	3
54	LFO sync	4
55	LFO sync	5
56	LFO sync	6
57	LFO offset	1
58	LFO offset	2
59	LFO offset	3
60	LFO offset	4
61	LFO offset	5
62	LFO offset	6
63	Filter type	1
64	Filter type	2
65	Filter type	3
66	Filter type	4
67	Filter type	5
68	Filter type	6
69	Transient generator volume	1
70	Transient generator volume	2
71	Transient generator volume	3
72	Transient generator volume	4
73	Transient generator volume	5
74	Transient generator volume	6
75	Transient generator waveform	1
76	Transient generator waveform	2
77	Transient generator waveform	3

<b>NRPN Nr.</b>	<b>Function</b>	<b>Voice</b>
78	Transient generator waveform	4
79	Transient generator waveform	5
80	Transient generator waveform	6
81	Transient generator frequency	1
82	Transient generator frequency	2
83	Transient generator frequency	3
84	Transient generator frequency	4
85	Transient generator frequency	5
86	Transient generator frequency	6
87	Audio output routing	1
88	Audio output routing	2
89	Audio output routing	3
90	Audio output routing	4
91	Audio output routing	5
92	Audio output routing	6
93	-	
94	-	
95	-	
96	-	
97	-	
98	-	
99	-	
100	PWM	1
101	PWM	2
102	PWM	3
103	PWM	4
104	PWM	5
105	PWM	6

<b>NRPN Nr.</b>	<b>Function</b>	<b>Voice</b>
106	FX Type	-
107	FX Routing	-
108	FX Amount	-
109	FX Distortion Type	-
110	FX Parameter 1	-
111	FX Parameter 2	-
112	FX Parameter 3	-
113	FX Parameter 4	-
114	FX Ratio	-
115	FX Ringmod Waveform	-
116	-	-
117	FX Delay Type	-

## 10 > FIRMWARE UPDATE

The software for the LXR can be updated using the memory card.

### 10.1. UPDATE PROCEDURE

- > Copy the latest LXR\_V2\_xxx.img to the root of the SD card.
- > Push and hold the encoder button while turning on the device.
- > "LXR Bootloader" will pop up in the display.
- > The LXR will check if the firmware image is valid and has the proper checksum.
- > If the check is passed, the update will be installed.
- > Do not turn off the power during installation!
- > Once done, the LXR will prompt you to reboot and the new firmware will be running.

### 10.2. BOOTLOADER ERROR MESSAGES

#### > LXR\*.img Not Valid!

File doesn't seem to be a valid firmware file. File header not matching

#### > LXR\*.img Wrong size!

Filesize differs from the size specified in the header. Probably an incomplete download.

#### > Wrong Checksum

File corrupted. File content does not match the checksum. Probably a download error.

## 11 > INTRODUCTION TO DRUM SYNTHESIS

This chapter will introduce you to the very basics of drum synthesis. Of course, this is just a small pointer in the direction of a few classic drum sounds. There are many more sounds to discover beyond the well-known drum sounds of the analogue classics. Nonetheless we will mostly focus on generating these, because they provide a good starting point for further exploration.

### 11.1. KICKS

The basis of nearly every kick sound is the simple combination of an oscillator and a decaying envelope modulating its pitch. The first 3 voices are perfect for this!

#### OSCILLATOR

A good starting point is a sine oscillator with a pitch around 30 to 35.

#### AMPLITUDE ENVELOPE

To decide how to set up the envelope, let's think about the kick sound. A kick has a sudden impact, so we want no attack (set to zero) since the sound starts with its maximum amplitude.

The decay controls the length of the kick sound. For the average kick a decay in the range 20-30 and a slope around 25 [exponential] gives a nice, not too short, not too long kick. For those booming 808 kicks you may want to set the decay higher.

#### PITCH ENVELOPE

To get some 'ooomph' and punch into your sound you need to set up the pitch envelope.

Try a decay and slope setting similar to the amplitude envelope as a start. All three parameters, decay, slope and modulation amount, have a great impact on the sound of the kick.

## CLICK

The attack sound is an important part of a kick. There is no general rule here. Try different transient generator settings for various clicks and pops or even slightly increasing the amplitude attack to give some softer bass drums.

## TIPS AND TRICKS

- > You can further shape the attack of the sound using the FM oscillator.
- > You want even more clicks in the attack? Why not enhance the click with a peak filter?

## 11.2. SNARE

The snare is a 2 component sound. There is a tonal part for the drum body and a noise part for the rattles.

Voice 4 of the LXR is designed with these 2 parts in mind. You have an oscillator for the tonal part and a noise generator with filter for the noise part. Since in most cases you want a high-pass filtered noise with an unfiltered drum body, only the noise generator is routed through the filter.

For most snare sounds you want the noise part to be louder than the tonal part, so try setting the mix parameter on the oscillator page to a value of around 100.

## TONAL PART

The tonal part is quite similar to the kick but not as pronounced. The typical snare does not need a loud click, nor that much modulation depth for the pitch envelope. Additionally, since a snare is smaller than a bass drum, the frequency of the oscillator has to be higher than on the kick.

## NOISE PART

For most cases highpass filtered noise with a moderate resonance setting is sufficient to get good results.

## AMPLITUDE ENVELOPE

We want a sharp percussion sound, so the attack will stay at zero. For the decay it depends on what kind of snare you are after.

- > Longer decay times with a very exponential slope setting as low as 5 to 10 will give you a short hit sound with a nicely decaying noise tail. The tail acts a little bit like a room reverb on the perception of the snare sound and gives more natural results.
- > Shorter decay times with a linear or exponential slope will give a very dry, direct snare.

## TIPS AND TRICKS

- > Not every snare needs tone and noise. Try using only the tonal part with a high pitch modulation envelope to get the classy Kraftwerk zap.

## 11.3. CLAP

A clap sound is made from noise. What's special about a clap, is the fuzzy attack of the sound. Imagine a few people clapping a rhythm. They will never all clap at exactly the same time. Each of them will have small variations in their timing, some will clap a little bit earlier, some a bit later.

## AMPLITUDE ENVELOPE

To simulate this behaviour we will use the repeat feature of the amplitude envelope. To get the classic clap sound, a setting of 3-4 repeats is good. Since the timing differences for the clap are very small, a short repeat time has to be chosen. An attack value below 10 is good.

Now you will have a short burst in the beginning of the sound. For the decay we need an exponential slope. A value below 10 is recommended.

## OSCILLATOR

A single white noise oscillator set to its maximum frequency.



## **FILTER**

BP filter 60-80 with high resonance settings gives good results.

## **11.4. HI-HAT**

### **OSCILLATOR**

For hi-hats, a complex, metallic noise spectrum is needed. Just use the 3 oscillators with high frequencies and modulation amounts to get a spectrum you like.

Sometimes, a simple white noise oscillator can give nice hats too.

### **AMPLITUDE ENVELOPE**

For hi-hats you have to set 2 decay times. One for the closed and one for the open hi-hat. Both are quite short, but the open hi-hat decay should be longer than the closed one. Use a very exponential slope below 10 for hat sounds.

## **FILTER**

Use a highpass filter to remove all low frequencies. A high frequency around 120 is used.

## **11.5. CYMBAL RIDE**

Cymbals are similar to hats. The difference comes from the envelope and filter settings.

### **OSCILLATOR**

The oscillator settings can be similar to those of the hi-hat sound.

### **AMPLITUDE ENVELOPE**

The only real difference to the hi-hat envelope is the decay time. We also use a strong exponential slope, but a much longer decay is needed. It is also

recommended to lower the volume of the voice otherwise the cymbal sound may be too loud.

## **FILTER**

A bandpass filter with high resonance settings and a frequency above 110 gives good results.

## **LFO**

The cymbal sounds really benefit from an LFO modulation to the filter frequency. Use a low modulation frequency and a sine wave with a gentle modulation depth so the different strikes don't sound exactly the same and the frequency spectrum of the sound changes a little bit over time.

## **11.6. BELLS**

### **REALISTIC BELLS**

Realistic bells are best achieved using FM oscillators. As long as you have a complex noisy, metallic spectrum, you just need to add an exponential decay amplitude envelope and a bandpass filter to get different kinds of bells. The sample rate reducer is also very useful to make the sound more metallic.

### **808 STYLE COWBELL**

The 808 cowbell consists of 2 detuned rectangle oscillators sent through a bandpass filter.

Recommended voice: drum voice 1-3.

### **FM PAGE**

- > Set mode to mix. The main and FM oscillators are now mixed together.
- > Set amount to 63. This sets the mix ratio between the 2 oscillators to 50% each.
- > Select a rectangle waveform.
- > Set frequency to something around 78.

## OSC PAGE

- > Select rectangle wave.
- > Set frequency to 71

## AMPLITUDE ENVELOPE

- > Attack 0
- > Very exponential slope around 2 to 5
- > Depending on the slope setting a short decay in the range of 25 to 50

## FILTER

- > Use a bandpass filter
- > Medium resonance around 70
- > Cutoff frequency around 92

## 11.7. MORE INFO ABOUT DRUM SOUND DESIGN

There are a lot of good sources about drum synthesis on the web. Two exceptionally good readings are:

- > The Sound on Sound synth secrets series has a lot of good articles for different drum sounds.
- > The owners manual of the Waldorf Attack synthesizer contains a lot of HowTos on drum synthesis.

Use your search engine of choice to find both documents.

# 12 > TECHNICAL INFORMATION

## 12.1. ELECTRICAL SPECIFICATION

### Main outs

Level: +4 dBu peak  
Output impedance: 100  $\Omega$  unbalanced

### Headphone out

Level: +4 dBu peak  
Output impedance: 50  $\Omega$  unbalanced

### Power

Unit power consumption: 3 W

## 12.2. HARDWARE

2 x 20 OLED screen  
MIDI In/Out with soft thru option  
4 x 1/4" audio out jacks  
1 x 3.5mm stereo headphone jack  
Electrically isolated hi-speed USB 2.0 port  
44.1 kHz, 16-Bit D/A converter  
Power connector: Center positive 5.5 x 2.5 mm barrel jack, 12 V DC, 1 A

## 12.3. PHYSICAL SPECIFICATION

Dimensions: 23 cm x 14,5 cm x 7cm (including knobs),  
Weight: 810g  
Do not expose instrument to temperatures over +50 C or below -20°C

## > SAFETY INSTRUCTIONS

Please follow the instructions for the use of the Erica Synths X Sonic Potions LXR-02 below, because only this will guarantee the proper operation of the module and ensure the warranty from Erica Synths.



Use the LXR-02 exclusively with the power supply unit (PSU) supplied with the system. Powering it with other PSU units may cause permanent damage to the device.



Water is lethal for most electric devices unless they have been rendered waterproof. The LXR-02 is NOT intended for use in a humid or wet environment. No liquids or other conducting substances should be allowed into the module. Should this happen, the module should be disconnected from mains power immediately, dried, examined and cleaned by a qualified technician.



Do not expose the instrument to temperatures above +50° C or below -20° C. If you have transported the instrument in extremely low temperatures, leave it at room temperature for an hour before plugging it in.



Transport the instrument carefully. Never let it drop or fall over. The Warranty does not apply to instruments with visual damage.



LXR-02 must be shipped in the original packaging only. Any instrument shipped to us for return, exchange and/or warranty repair must be in its original packaging. All other deliveries will be rejected and returned to you. Ensure that you keep the original packaging and technical documentation.

## > DISPOSAL

This device complies with EU guidelines and is manufactured and confront RoHS without the use of lead, mercury, cadmium or chrome. Nevertheless, this device is special waste and disposal in household waste is not recommended.

User manual by Julian Schmidt@Sonic Potions.

Design by Ineta Briede@Black8.

Special thanks to Leoš Hort aka hrtl for developing the factory preset kits.

Copying, distribution or any commercial use in any way is prohibited and needs the written permission of Erica Synths.

The specifications are subject to change without notice. If you have any questions, feel free to contact us via SUPPORT section on [www.ericasyths.lv](http://www.ericasyths.lv)

You will find the Erica Synths terms of warranty at  
[www.ericasyths.lv](http://www.ericasyths.lv)

Items for return, exchange and/or warranty repair should be sent us  
according to the guidelines on SUPPORT section on [www.ericasyths.lv](http://www.ericasyths.lv)

Erica Synths  
Andrejostas St. 43  
Riga  
Latvia  
LV-1045